



BID BULLETIN 01

Date: 18 August 2021

Project Title: Supply and Delivery of Solar Streetlights-Rebidding (GOODS-21-21-R)

Location: VSU Main, Visca, Baybay City, Leyte

Bidders are hereby informed/reminded of the following addendums/amendments/clarifications:

I. LIST OF REQUIREMENTS

| (1st Envelope) TECHNICAL COMPONENT ENVELOPE | |
|---|---|
| <i>Legal Documents</i> | |
| 1 | PhilGEPS Certificate of Registration (Platinum) |
| | or |
| | a. Registration Certificate (SEC, DTI or CDA) |
| | b. Mayor's/Business Permit |
| | c. Tax Clearance |
| <i>Technical Documents</i> | |
| 2 | Statement of All On-Going Government & Private Contracts |
| 3 | Statement of Bidder's Single Largest Completed Contract (at least 50% of the ABC or Php 4,787,500.00) |
| | Or |
| | Statement of at least two (2) similar completed contracts w/ total amount of at least Php 4,787,500.00 and the largest of which should be at least Php 2,393,750.00 . |
| 4 | Bid Security |
| 5 | Technical Specifications |
| 6 | SCHEDULE of Requirements/Production and delivery schedule |
| 7 | Manpower Requirements |
| 8 | After Sales service/parts from acceptance of delivered goods (at least 1 year for equipment) |
| 9 | Original Duly Signed Omnibus Sworn Statement |
| <i>Financial Documents</i> | |
| 10 | The Supplier's Audited Financial Statements |
| 11 | Net Financial Contracting Capacity (at least PhP 9,575,000.00) |
| | Or |
| | Committed Line of Credit (at least Php 957,500.00) |
| (2nd Envelope) FINANCIAL COMPONENT ENVELOPE | |
| 12 | Original of duly signed and accomplished Financial Bid Form |
| 13 | Original of duly signed and accomplished Price Schedule(s) |



Please take note:

In the **Technical Specifications**, bidders must state either “Comply” or “Not Comply” **against each of the individual parameters of the specifications** per item stating the corresponding performance parameter of the equipment offered. Statements of “Comply” or “Not Comply” must be supported by evidence in the **Bidders Bid** and cross-referenced to that evidence. Evidence shall be in the form of **manufacturer’s un-amended sales literature (Data Sheets), unconditional statements of specification and compliance issued by the manufacturer, samples, independent test data, and Brand and Model** as appropriate. A statement that is not supported by evidence or is subsequently found to be contradicted by the evidence presented will render the Bid under evaluation liable for rejection. A statement either in the Bidders statement of compliance or the supporting evidence that is found to be false either during Bid evaluation, post-qualification or the execution of the Contract may be regarded as fraudulent and render the Bidder or supplier liable for prosecution subject to the provisions of **ITB Clause 3.1(a)(ii)** and/or **GCC Clause 2.1 (a)(ii)**.

II. Preparation of Electronic Bid (for bidders who prefer electronic bid submission)

1. Convert all documents into Portable Document Format (PDF) and should be printable.
2. Properly label all documents for prompt identification. Filename of documents, whichever are applicable to the bidder, should be as follows:

| Document | Filename (in PDF form) |
|--|----------------------------------|
| 1. PhilGEPS Certificate of Registration (Platinum) | PhilGEPS |
| 2. Registration Certificate (SEC/DTI) | Registration Certificate |
| 3. Mayor’s/Business Permit | Mayor’s-Business Permit |
| 4. Tax Clearance | Tax Clearance |
| 5. Statement of On-Going Government & Private Contracts | Statement of On-Going Contracts |
| 6. Statement of Bidder’s Single Largest Completed Contract | SLCC |
| 7. Statement of at least two (2) similar completed contracts | Statement of Completed Contracts |
| 8. Bid Security | Bid Security |
| 9. Technical Specifications | Technical Specifications |
| 10. SCHEDULE of Requirements/ Production and delivery schedule | Schedule of Requirements |
| 11. Manpower Requirements | Manpower Requirements |
| 12. After Sales service/parts | After Sales |
| 13. Omnibus Sworn Statement | Omnibus Sworn Statement |
| 14. Audited Financial Statements | Audited Financial Statements |
| 15. Net Financial Contracting Capacity | NFCC |
| 16. Committed Line of Credit | CLC |
| 17. Bid Form | Bid Form |
| 18. Price Schedule | Price Schedule |

3. Create two (2) folders that are password-protected. The first folder should contain all requirements under Technical Component checklist as presented under Section VIII.



The second folder should contain all requirements under Financial Component checklist.

4. Compress the two (2) folders and name as follows: a) first folder: **Technical Documents**, b) second folder: **Financial Documents**.
5. Email the 2 compressed folders to Ms. Jessamine C. Ecleo at jessamine.ecleo@vsu.edu.ph before the deadline.

III. Changes in the Bidding Documents

A.

| Original | Amendment |
|--|--|
| <p>5. A complete set of Bidding Documents may be acquired by interested Bidders on <i>06 August – 26 August 2021 until 1:30 PM</i> from the given address and website(s) below and upon payment of the applicable fee for the Bidding Documents, pursuant to the latest Guidelines issued by the GPPB, in the amount of Ten Thousand Pesos (PhP 10,000.00). The Procuring Entity shall allow the bidder to present its proof of payment for the fees in person, by facsimile, or through electronic means.</p> | <p>5. A complete set of Bidding Documents may be acquired by interested Bidders on <i>06 August – 26 August 2021 until 1:30 PM</i> from the given address and website(s) below and upon payment of the applicable fee for the Bidding Documents, pursuant to the latest Guidelines issued by the GPPB, in the amount of Ten Thousand Pesos (PhP 10,000.00). The Procuring Entity shall allow the bidder to present its proof of payment for the fees in person, by facsimile, or through electronic means.</p> <p style="color: red;">The Bidders may also deposit the applicable fee to Visayas State University Landbank Account:</p> <p style="color: red;">Account Name: Visayas State University Fund 164</p> <p style="color: red;">Account Number: 3572-1000-13</p> <p style="color: red;">And send the deposit slip to Ms. Jessamine C. Ecleo at jessamine.ecleo@vsu.edu.ph</p> |

B. Other Changes

| Original | Amendment |
|---|--|
| <p>ITB Clause 5.3</p> <p>For this purpose, contracts similar to the Project shall be:</p> <p style="padding-left: 40px;">a. <i>Solar Streetlights - Rebidding</i></p> <p>completed within two (2) years prior to the deadline for the submission and receipt of bids.</p> | <p>ITB Clause 5.3</p> <p>For this purpose, contracts similar to the Project shall be:</p> <p style="padding-left: 40px;">b. <i>Solar Streetlights - Rebidding</i></p> <p>1. completed within four (4) years prior to the deadline for the submission and receipt of bids.</p> |



IV. Revised List of Goods and Technical Specifications

- Some Specifications were added (**red**) and/or deleted (**blue**)
- Some Quantities and Unit Prices (ABC) were changed

| Item No. | Description | Unit | Qty | ABC/Unit | Total ABC |
|----------|---|------|-----|---------------------|---------------------|
| 1 | Supply and Delivery of Solar Streetlights | lot | 1 | 9,575,000.00 | 9,575,000.00 |
| | Single Garden/Victorian Solar Lamp with Segmented Post | pcs | 30 | | |
| | Specification for Lamp and Segmented Post: | | | | |
| | ☐20W LED Power | | | | |
| | ☐20W Solar Panel (Built-in) | | | | |
| | 12000-delete Lithium Battery (Built-in) at least 5 years battery life | | | | |
| | ☐5000K White | | | | |
| | ☐Equipped with Motion Sensor, Time Control or Mixed Mode-delete | | | | |
| | ☐Photo Sensor (Built-in)-delete | | | | |
| | ☐Voltage regulated | | | | |
| | ☐Auto on/off | | | | |
| | ☐Lamp Size (mm): atleast 425 x 425 x 445 | | | | |
| | ☐IP 65 rating | | | | |
| | ☐CE, ROHS, IP Certified | | | | |
| | ☐Pole Height: 3 meters | | | | |
| | ☐Bottom Pole Diameter: 2 inches | | | | |
| | ☐Top Pole Diameter: 2 inches | | | | |
| | ☐Base Plate Dimension (Lx WxT): 4 in x 4 in x 16mm | | | | |
| | ☐Anchor bolt Dimension (Dia x L): 1/2 in x 8 in | | | | |
| | ☐Epoxy primer and Black paint coating for all weather resistance | | | | |
| | ☐At least 3 years warranty on service and parts | | | | |
| | Solar Street Lights with Segmented Post/ Hot dipped tapered | pcs | 300 | | |
| | Specification of Solar Street Light and Segmented Post: | | | | |
| | ☐18V/60W monocrystalline silicone solar panel | | | | |
| | ☐Built-in Lithium Iron-delete ion Battery (at least 8 years battery life) | | | | |
| | ☐Cree LED Chip | | | | |
| | ☐30W-40W LED Lights | | | | |
| | ☐3300 -4400 Lumens | | | | |
| | ☐3000K-6500K Correlated Color Temperature (CCT) | | | | |
| | ☐Aluminum Alloy Shell Material | | | | |
| | ☐Equipped with Motion Sensor, Time Control or Mixed Mode | | | | |
| | ☐at least 6-7 hours charging time by sun | | | | |



| | | | | |
|--|--|-----|----|---------------------|
| | ☑at least 3-5 rainy days, 12 hours per night discharge time | | | |
| | ☑Adjustable Angle (15, 30, 45) | | | |
| | ☑Compatible with remote control | | | |
| | ☑IP 65 rating | | | |
| | ☑CE, ROHS, IP Certified | | | |
| | ☑Pole Height: 5 meters | | | |
| | ☑Bottom Pole Diameter: 3 inches | | | |
| | ☑Top Pole Diameter: 2-2 1/2" | | | |
| | ☑Base Plate Dimension (Lx WxT): 6 in x 6 in x 16mm | | | |
| | ☑Anchor bolt Dimension (Dia x L): 5/8 in x 12 in | | | |
| | Epoxy primer and Black paint coating for all weather resistance | | | |
| | ☑At least 3 years warranty on service and parts | | | |
| | Double Arm Garden/Victorian Solar Lamp with Post | pcs | 92 | |
| | Specification of Solar Street Light and Segmented Post: | | | |
| | ☑ 20W LED Power | | | |
| | ☑ 20W Solar Panel (Built-in) | | | |
| | Lithium Battery (Built-in) at least 5 years battery life | | | |
| | ☑ 5000K White | | | |
| | ☑ Voltage regulated | | | |
| | ☑ Auto on/off | | | |
| | ☑ Lamp Size (mm): atleast 425 x 425 x 445 | | | |
| | ☑IP 65 rating | | | |
| | ☑CE, ROHS, IP Certified | | | |
| | ☑Pole Height: 3 meters | | | |
| | ☑Bottom Pole Diameter: 2 inches | | | |
| | ☑Top Pole Diameter: 2 inches | | | |
| | ☑Base Plate Dimension (Lx WxT): 4 in x 4 in x 16mm | | | |
| | ☑Anchor bolt Dimension (Dia x L): 1/2 in x 8 in | | | |
| | ☑ Epoxy primer and Black paint coating for all weather resistance | | | |
| | ☑At least 3 years warranty on service and parts | | | |
| Note: Supplier should have Service Center within Region 8 due to Covid issues | | | | |
| | TOTAL ABC (for this project): | | | 9,575,000.00 |

Attachment: Appendix A. Sample Pictures, Diagram and Designs

Sgnd
DILBERTO O. FERRAREN
BAC Chairman



Appendix A: Sample Pictures, Diagram and Designs

Item No. 1. Single Garden/Victorian Solar Lamp with Post (30 pcs)

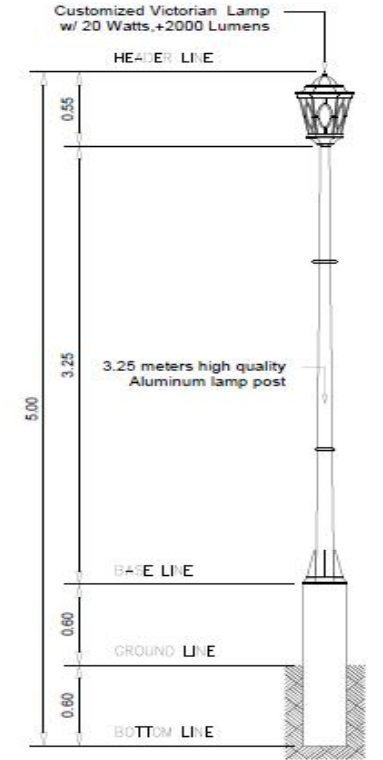

4

DETAIL OF STREET LIGHT

Scale: 1:30

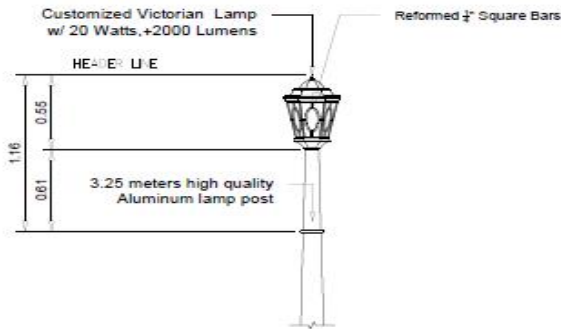

2

DETAIL OF CASEMENT

Scale: 1:60

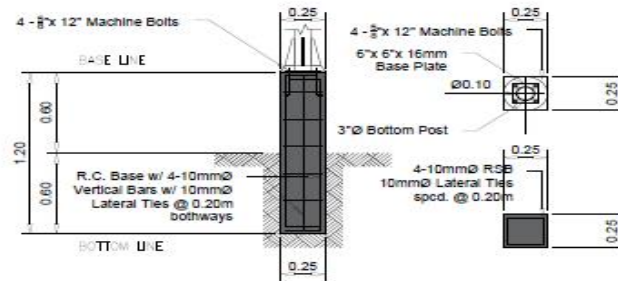

3

DETAIL OF BASE

Scale: 1:60

| | | | | | | | |
|---|--------------------|--|--|---|---|---|---|
| TIN: _____ PRC: _____ PTR: _____ Date: _____ Place: _____ | Approved by: _____ | Project Title: STREET LIGHTS - 2 Location: Main VSU Campus, Baybay City, Leyte Philippines, 6521 | Checked by: Engr. WILFRIDO VALENZONA Director, PRC | Recommending Approval: Dr. REMBERTO A. PATINDOL VP for Administration & Finance | Approved by: Dr. EDGARDO E. TULIN VSU President | Concept by: _____ AutoCAD by: _____ Date Started: _____ Date Finished: _____ Place: _____ | A1 01 SHEET NO. 01 01 |
|---|--------------------|--|--|---|---|---|---|



Item No. 2. Solar Street Lights with Segmented Post (300 pcs)



1 PERSPECTIVE
Scale: 1:100

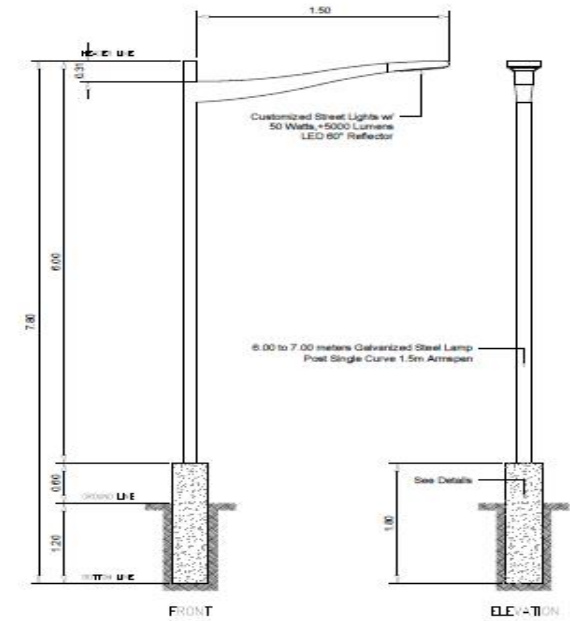

4 DETAIL OF STREET LIGHT
Scale: 1:60

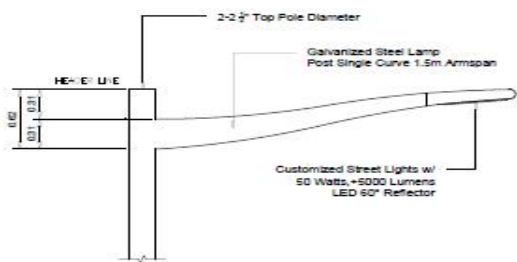

2 DETAIL OF CASEMENT
Scale: 1:40

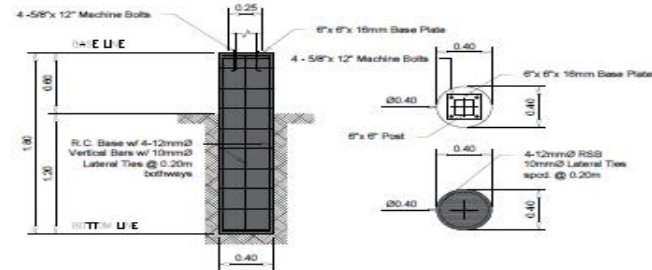

3 DETAIL OF BASE
Scale: 1:40

| | | | | | | | | | | | |
|--|--------------------|---|--|---|---|------------------------------------|------------------------------------|--------------------------------------|---------------------------------------|-------------|---|
| IN: _____ PRC: _____ PPR: _____ Date: _____ Place: _____ | Approved by: _____ | Project Title: <p style="text-align: center;">STREET LIGHTS - 3</p> Location: Main VSU Campus, Baybay City, Leyte Philippines, 6521 | Checked by: Engr. MARQUESS WALDONA | Recommending Approval: Dr. REMBERTO A. PATINDOL | Approved by: Dr. EDGARDO E. TULIN | Created by: VSU/PRC/2021 | AutoCAD by: VSU/PRC/2021 | Date Started: VSU/PRC/2021 | Date Finished: VSU/PRC/2021 | Name: _____ | <div style="border: 1px solid black; border-radius: 50%; padding: 5px; display: inline-block;"> A1 01 01 01 </div> |
|--|--------------------|---|--|---|---|------------------------------------|------------------------------------|--------------------------------------|---------------------------------------|-------------|---|



Item No. . Double Arm Garden/Victorian Solar Lamp with Post (92 pcs)

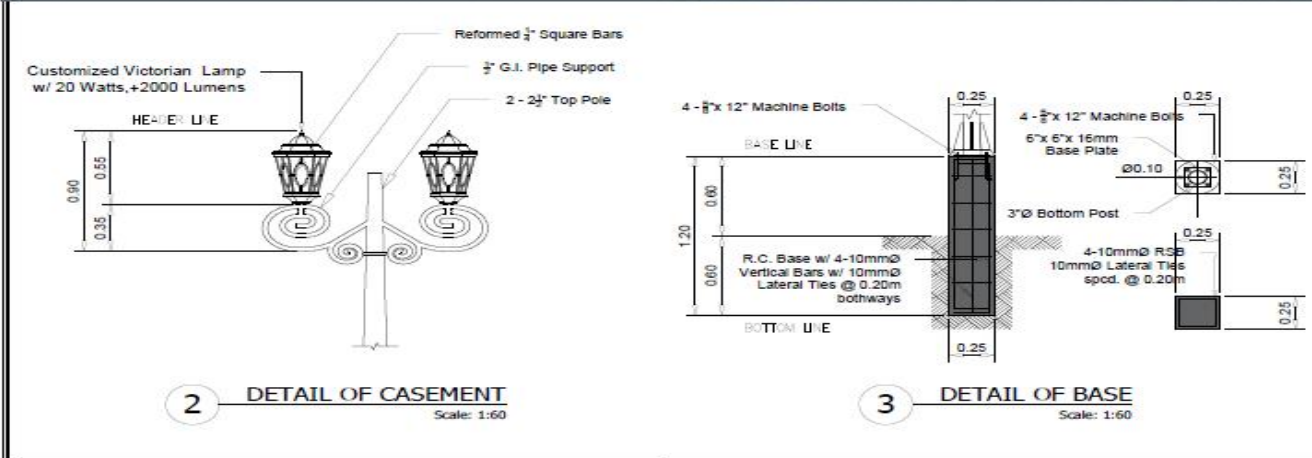
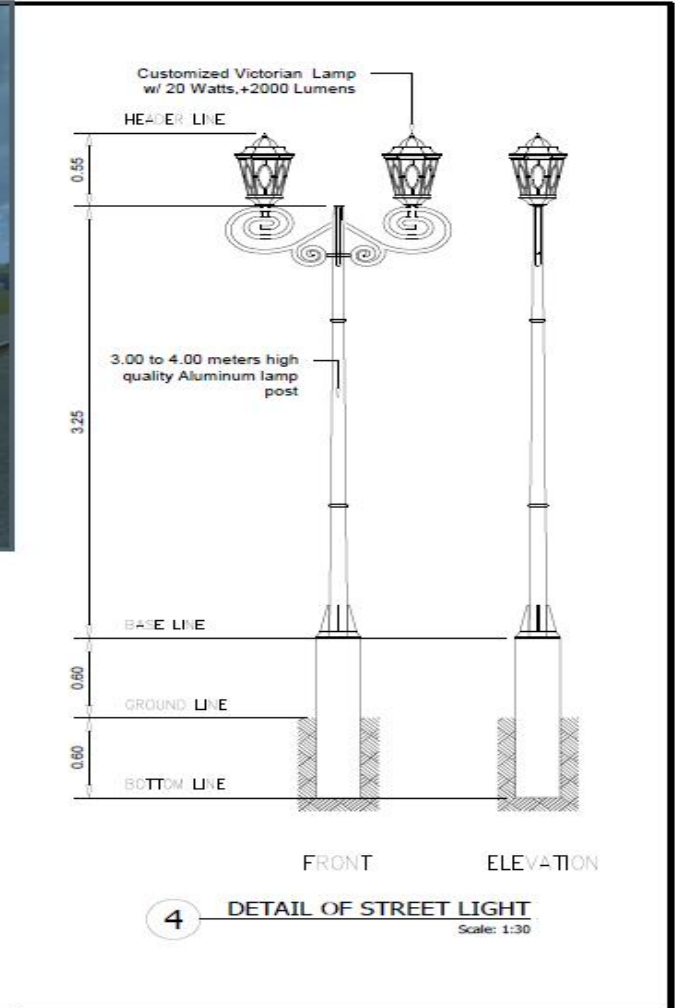

| | | | | | | | |
|---|--------------|--|--|---|---|---|-----------------------------|
| IN: PREC: IPR: Date: Place: | Approved by: | Project Title: STREET LIGHTS - 1 | Checked by: Engr. WARD L. R. VALENZONA | Recommending Approval: Dr. REMBERTO A. PATINDOL | Approved by: Dr. EDGARDO E. TULIN | Concept by: AutoCAD by: Date Started: Date Finished: Place: | A1 01 SHEET NCL 01 01 |
|---|--------------|--|--|---|---|---|-----------------------------|